

## Partial User References (not complete list) of our Fume Extraction Systems

SNo.	Customer's Name & City	Qty	SNo.	Customer's Name & City	Qty
1	509 Army Base Workshop, Agra	28	40	EFD Induction Private Limited	2
2	ABB India Limited, Bangalore	5	41	Effee Induction Pvt. Ltd., Bangalore	1
3	ABB Limited, Vadodara	1	42	Effronics Systems Pvt. Ltd., Vijayawada	28
4	ACE Manufacturing Systems Limited, Bangalore	5	43	Electromags Automotive Products Pvt. Ltd., Chennai	2
5	Adarsh Infrainterio Pvt. Ltd., Mumbai	5	44	Eletec Engineers, Amabala Cantt	1
6	ADS Sensortech Pvt. Ltd., Bangalore	1	45	Embedded IT Solution (India) Private Limited, Hyderabad	1
7	Air Force Station, Delhi	1	46	EME Automation	1
8	Airtech Enterprises	2	47	Epcos India Private Limited, Nashik	1
9	Aluminium Industries Limited, Trivandrum	8	48	Erhardt + Leimer (India) Pvt. Ltd., Ahmedabad	1
10	Amphenol Omniconnect India Pvt. Ltd., Chennai	1	49	Flexi Efficads Pvt. Ltd., Bangalore	1
11	Anicad Systems, Bangalore	1	50	Flextronics Tech (I) Pvt. Ltd., Kanchipuram	53
12	Apex Electronics, Secunderabad	5	51	Fokker Elmo Sasmos Interconnection Systems Ltd.	2
13	Arya Electronics, Trivandrum	1	52	Futura Automation Pvt. Ltd., Bangalore	2
14	Astra Microwave Products Ltd., Hyderabad	14	53	Genus Power Infrastructures Ltd., Guwahati	3
15	AVM Labs Private Limited, Chennai	3	54	Genus Power Infrastructures Ltd., Jaipur	42
16	Bharat Electronics Limited, Bangalore	129	55	Goodrich Aerospace Services Pvt. Ltd., Bangalore	25
17	Bharat Electronics Limited, Navi Mumbai	2	56	Hanoch Automations Pvt. Ltd.	2
18	Bharat Electronics Limited, Pune	14	57	HELA Systems Pvt. Ltd.	1
19	Bharat Electronics Ltd., Ghaziabad	6	58	Hella India Automotive Private Ltd., Gurgaon	1
20	Bharat Electronics Ltd., Machilipatnam	3	59	Himanshu Traders, Kanpur	2
21	Bharathi MRO Industrial Products Pvt. Ltd., Coimbatore	1	60	Hindustan Aeronautics Ltd., Hyderabad	16
22	Bhavyabhenu Electronics (P) Ltd., Hyderabad	4	61	Honeywell Technology Solutions Lab Pvt. Ltd., Bangalore	2
23	Blue Chip Electronics, Secunderabad	33	62	HTL Limited, Chennai	3
24	BPL Medical Technologies Ltd., Kerala	1	63	IJPN Technologies (I) Pvt. Ltd., Pinjore	12
25	BuffaloGrid Project Private Limited	1	64	Innovate Software Solutions Pvt. Ltd., Bangalore	1
26	Captronic Systems Pvt. Ltd., Bangalore	4	65	INTELLIC SYSTEMS	1
27	Centum Electronics Ltd., Bangalore	4	66	IoTech World Avigation Pvt. Ltd., Gurugram	1
28	GET Power Solutions India Pvt. Ltd., Chennai	2	67	JAY CEE & Company, New Delhi	1
29	CHARA TECHNOLOGIES	1	68	Kaynes Technology India Pvt. Ltd., Gurgaon	1
30	Chip Test Engineering Pvt. Ltd., Chennai	2	69	Keltron Electro Ceramics Ltd., Kerala	13
31	Colloidal Solutions Private Limited, Bengaluru	1	70	Kent RO Systems Ltd., Noida	7
32	Continental Automotive Components (I) Pvt. Ltd., Bangalore	1	71	Kerala State Electronics Dev. Corp. Ltd., Karakul	33
33	Cyient DLM Private Limited	10	72	Konarak Industria Pvt. Ltd., Bangalore	1
34	Danfoss Industries Pvt. Ltd., Chennai	1	73	Krishan Lal Doomra, Bikaner	6
35	Danlaw Electronics Assembly Limited, Goa	3	74	Krohne Marshall Pvt. Ltd., Pune	1
36	Denso India Private Limited, Noida	2	75	L&T Technology Services Limited, Bangalore	1
37	Dhiman Associates, Chandigarh	1	76	Labsources, Bangalore	1
38	DivineTechno Engineers, Vadodara	7	77	Lapp India Pvt. Ltd., Vadodara	1
39	Eagle Industries, Rajkot	1	78	Lapp India Pvt. Ltd., Bangalore	1

Warranty is 12 months from the date of invoice.

It excludes any sort of mechanical damage and all consumable parts as Filters, Extraction Arms and Hoods.

**on-site services can be provided at extra charges if pre-paid by customer in advance**

While the information contained herein in, has been carefully compiled to the best of our knowledge, nothing is intended as representation and warranty on our part; and no statement shall be construed as recommendation to infringe any of existing patents. We accept no liability of whatsoever for any faults and errors in the information contained herein. Contents of this catalogue and specifications of the products, are subject to change without notice due to continuous improvements.

## Partial User References (not complete list) of our Fume Extraction Systems

SNo.	Customer's Name & City	Qty	SNo.	Customer's Name & City	Qty
79	Latecoere India Private Limited, Belgaum	6	118	Seiko-Maraica Electrical	1
80	Lucas TVS Limited, Pondicherry	2	119	Semi-Conductor Laboratory, Mohali	4
81	Marathon Electric India Pvt. Limited, Faridabad	2	120	Shakti Pumps (India) Ltd., Pithampur	1
82	Marquardt India Pvt. Ltd., Pune	1	121	Shivalik Bimetal Controls Ltd., Solan	11
83	Mediatek India Technologies Pvt. Ltd., Noida	1	122	Shree Annapurna Enterprises	1
84	Mersen India Private Limited, Bangalore	21	123	Shriji Metal Industries, Amreli	1
85	Micron Instruments Private Limited, Barwala	1	124	Siemens Limited., Aurangabad	1
86	Molex India Pvt. Ltd., Bangalore	15	125	Sinhal Udyog Pvt. Ltd., New Delhi	2
87	Motherson Sumi Systems Ltd., Noida	3	126	Skipper Limited, Howrah	1
88	Motherson Sumi Wiring India Limited, Kancheepuram	1	127	SLN Technologies Pvt. Ltd., Bangalore	1
89	MPlastics Toys and Engineering Pvt. Ltd., Krishnagiri	1	128	Smash Electronics, Pune	1
90	MTE India Private Limited, New Delhi	1	129	Spaartasoft Technology Solutions, Pune	3
91	Muffaddal Tools & Hardware, Bangalore	7	130	Sreenivasulu Cherukuru, Sriharikota	2
92	Multilink, Mysore	8	131	SRIVIDYA CONTROLS, Bangalore	1
93	Narayana Hrudayalaya Limited, Bangalore	3	132	Stead Fast Engineers Pvt. Ltd., Faridabad	6
94	NEESHU Marking and Coding Pvt. Ltd., Nagpur	1	133	Stellar Information Technology Pvt. Ltd., Gurugram	1
95	Nucon Aerospace Pvt. Ltd., M.R.R. Distt	1	134	Success Solutions, Nashik	1
96	Panasonic India Private Ltd., Haryana	1	135	Sungrow Developers India Private Limited, Bangalore	1
97	Payal Mechanical & Engineering Works, Chandigarh	14	136	Suprajit Engineering Limited, Bangalore	1
98	PICL India Pvt. Ltd., Faridabad	5	137	Syrma SGS Technology Ltd., Chennai	30
99	Prism Automation Pvt. Ltd.	1	138	System Controls Technology	1
100	PVR Controls, Mumbai	3	139	Tata Advanced Systems Limited, Bangalore	2
101	Quantum SMT Technologies Pvt. Ltd, Gurgaon	10	140	Tata Power Solar Systems Ltd.	1
102	Rajshree Electro-Systems, Panvel	6	141	TE Connectivity India Pvt.Ltd., Bangalore	5
103	Rama Exports, Mumbai	1	142	Titan Company Limited	1
104	Raphe MPhibr Private Limited, Noida	1	143	Titan Company Ltd, Hosur	1
105	Rapid Global Business Solutions India Private Ltd.	1	144	Titan Company Ltd., Bangalore	1
106	Rcube Technologies, Noida	1	145	Toyota Techno Park India Pvt. Ltd., Ramnagar	1
107	REFURB TECH	1	146	Tractors and Farm Equipment Ltd., Chennai	2
108	RenewSys India Pvt. Ltd, R.R. Distt.	2	147	Trascon Interconnections Systems Pvt. Ltd., Bangalore	1
109	RHINE POWER PRIVATE LIMITED, Gurugram	2	148	Urban Engineering Association Pvt. Ltd., Kolkata	1
110	ROSSELL TECHSYS (Div. of Rossel India Ltd), Bangalore	6	149	Ushodaya Electronics, Hyderabad	3
111	RP Network System, Bangalore	5	150	Veeyes Electronics Pvt. Ltd., Bangalore	1
112	SAEL Solar MFG Pvt. Ltd., Ferozpur	2	151	Venimadhav Moolchand Suppliers, Kanpur	6
113	Salzer Electronics Ltd., Coimbatore	1	152	V-Guard Industries Limited, Cochin	1
114	Samvardhana Motherson International Ltd., Noida	1	153	Vikram Sarabhai Space Centre, Thiruvananthapuram	31
115	Sasmos HET Technologies Ltd., Bangalore	9	154	Vilasini Harness Solutions Pvt. Ltd., Mohali	1
116	Schneider Electric India Pvt. Ltd., Bangalore	1	155	Virtual Forest Private Ltd., Bangalore	1
117	Schneider Electric IT Business, Rudrapur	2	156	Zones Corporate Solution Pvt. Ltd.	1

Warranty is 12 months from the date of invoice.

It excludes any sort of mechanical damage and all consumable parts as Filters, Extraction Arms and Hoods.

**on-site services can be provided at extra charges if pre-paid by customer in advance**

While the information contained herein in, has been carefully compiled to the best of our knowledge, nothing is intended as representation and warranty on our part; and no statement shall be construed as recommendation to infringe any of existing patents. We accept no liability of whatsoever for any faults and errors in the information contained herein. Contents of this catalogue and specifications of the products, are subject to change without notice due to continuous improvements.

## What's in Soldering Fumes?

The smoke produced while soldering can easily expose one to Hazardous Fumes. Soldering, a process in which heat is used to join two metals together by melting a third metal or solder, produce fumes that can be hazardous to the operators breathing zone.

Metal vapors are formed as solder evaporates and gases are produced as flux evaporates. Metal vapors are released into the air when low melting point alloys are soldered together. Due to rosin fluxes, including resin acid particles, soldering process produces fumes that can cause long-term discomfort & health problems.

The human body exposed to solder fumes directly because the fumes rise vertically during hand soldering practices. Operators are exposed to lead during soldering. If handled incorrectly, lead can cause chronic health effects, such as reproductive problems, digestive problems, memory and concentration problems, and muscle and joint pain.

The health hazards due to common solder components are as below:

**Lead:** May cause lead poisoning, kidney disease, hypertension, and weight loss. Targets the gastrointestinal tract, nervous system, kidneys and blood. Symptoms include metallic taste in the mouth, nausea, vomiting, headache, cramps, nervousness, and insomnia

**Tin:** Considered relatively harmless but may generate benign pneumoconiosis, or eye, skin, and respiratory system irritation

**Silver:** May create throat irritation, blue gray eyes, nasal septum irritation, and gastrointestinal disturbance

**Copper:** Can produce eye and upper respiratory irritation and metal fume fever. Metal fume fever symptoms include fever, chills, aches, pains, nausea, and dizziness.

**That is why you need to come up with a way to eliminate that toxic smoke whenever you are soldering. But here is where the confusion comes in: which one should choose between Fume Extraction System or Fan type Fume Absorber**

## Which one should you choose between: Fume Extraction System vs Fan type Absorber

The answer to this is simple - Go with the Fume Extraction System. A fan type absorber will just blow around the smoke produced and not filter it completely – You will still breathe the fumes. A Fume Extraction System not only sucks the fumes but it also filters the fumes thus making it an efficient Solder Fume Filtration System. Despite its cost, a soldering Fume Extraction System is way superior and efficient than a soldering fan type absorber.

### Filtration Process of Fume Extraction System

#### Pre-Filter

Filter out larger particles of solder fumes

#### Middle Filter

Filter out coarse particles of solder fumes and also filter out bacteria, fungi etc.

#### Main HEPA Filter

Activated carbon filters and filter out all toxic and harmful gases to make the air pure and free from pollutant

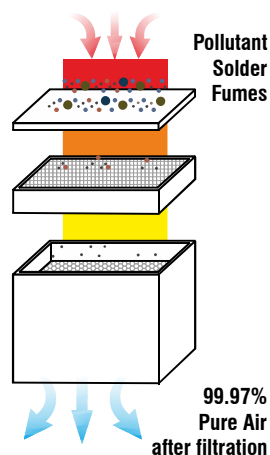

### Filtration Process of Fan type Fume Absorber

#### Carbon Activated Filter

Filter out solder fumes partially not completely

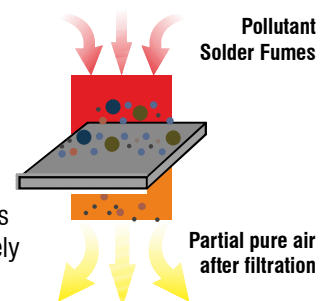

Warranty is 12 months from the date of invoice. It excludes any sort of mechanical damage and all consumable parts as Filters, Extraction Arms and Hoods.

on-site services can be provided at extra charges if pre-paid by customer in advance

While the information contained herein in, has been carefully compiled to the best of our knowledge, nothing is intended as representation and warranty on our part; and no statement shall be construed as recommendation to infringe any of existing patents. We accept no liability of whatsoever for any faults and errors in the information contained herein. Contents of this catalogue and specifications of the products, are subject to change without notice due to continuous improvements.

Couple of 100's (in repeat orders) working reliably all over India for the last many years

**3-Stage Filters for 99.97% cleaning**  
**Silent operation with noise < 55 dBA\***  
**Reliable & powerful brushless turbine**  
**Ready-to-use, no plumbing required**

[Click here to view Video](#)



FumePRO101  
Main  
Extraction  
Control  
Unit

Digital Display Indicator



**System Choke Alarm:**  
When display shows circular movement clockwise plus OFF and system beeps, it means any of Filters needs replacement.

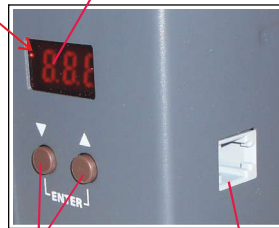

Airflow  
Setting  
Switches

Speed Control  
Regulator  
Connector

Burn-proof Silicon  
Rubber Round Hoods  
105mm dia

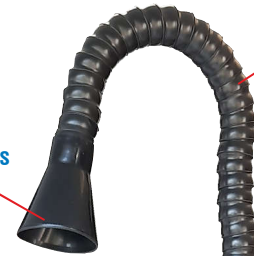

Rigid Gooseneck  
Arms can be  
positioned  
anywhere on  
table and will  
stay in  
same place

No Plumbing required  
Just position on the  
Table as needed

Ready-to-use  
Complete  
Package

No Plumbing  
required

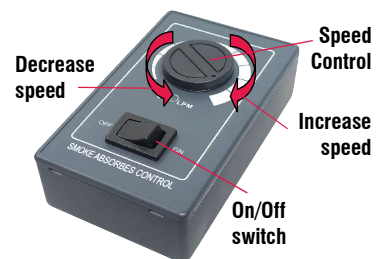
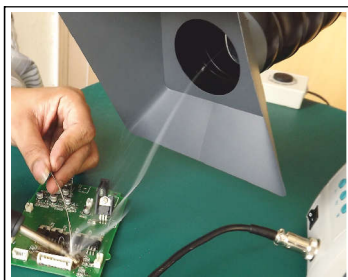

Speed Control Regulator

### Scope of Supply

- 1x FumePro101 Main Extraction Unit
- 1x Extraction Arms (50mm dia, 1 meter long)
- 1x Round Fume Absorbing Hood (105mm dia.)
- 1x Speed Control Regulator
- 2x Spare Pre-Filters

### Specifications

- Input Power Supply : 230V/50Hz, 120W
- No of Workplaces : 1
- Stationary Pressure : 2400 Pa
- Maximum Airflow Rate : 120m<sup>3</sup>/h
- Filtering Efficiency (0.3um) : 99.97%
- Noise Level : <55dB\*

\* at distance of 1 meter & also at typical speed of turbine

shown trademarks are property of their respective owners.

Warranty is 12 months from the date of invoice. It excludes all consumable parts as Filters, Extraction Arms and Hoods

While the information contained herein in, has been carefully compiled to the best of our knowledge, nothing is intended as representation and warranty on our part; and no statement shall be construed as recommendation to infringe any of existing patents. We accept no liability of whatsoever for any faults and errors in the information contained herein. Contents of this catalogue and specifications of the products, are subject to change without notice due to continuous improvements.

Couple of 100's (in repeat orders) working reliably all over India for the last many years

### Features

- Hassle-free easy-to-start operation with all inclusive kit supplied
- Easy-to-manoeuvre positioning of Fumes Extraction Arms
- Reliable & virtually maintenance-free Brushless DC Turbine
- Has low noise (< 55 dBA) in operation as compared to other competitor's models
- Special Filters design removes hazardous gaseous/adhesive substances from fumes.
- Normally low cost Pre-Filter only needs periodic replacement when there is choking
- Quick delivery of all spares parts as we keep enough stocks of the same all the time

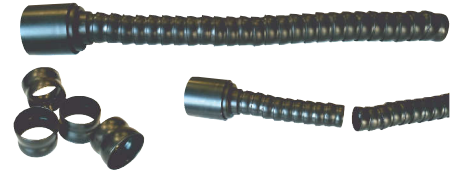

Length of Extraction Arm is easily adjustable, as this is made from press-fit type small sections which are easily adjustable in length by selection of these sections as per required length.

### KHRR105-50

Rubber Round Absorber  
- 105mm diameter  
- ESD Safe & Heat resistant



FumePRO101-50LC is a volume extraction type powerful single operator ready-to-use Solder Fume Extraction System. It is designed for continuous and reliable working on production line. Its powerful and maintenance-free brushless turbine combined with electronic speed control, provides clean working environment at low maintenance cost. The electronic Speed Controller regulates air-flow volume continuously.

Ready-to-use Solder Fumes Extraction System Model FumePRO101-50LC is fitted with **3-stage Filters**: Pre-Filter, Middle Filter and HEPA Filter. Combination of these Filters cleans polluted air by separating 99.9% contaminated solder fumes. This System is designed for use both in industrial and laboratory environment. All it needs is the Mains Input Power Supply only.

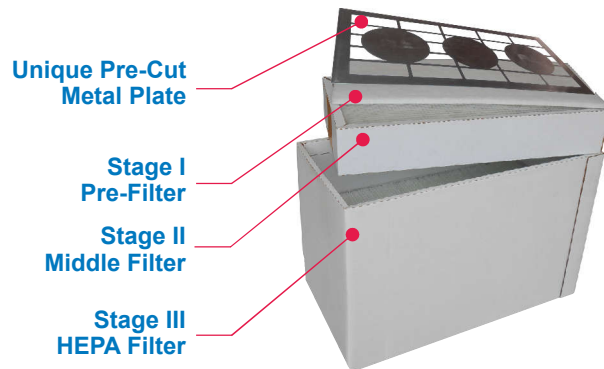

### Details of 3-Stage Filters used in this Fume Extraction System

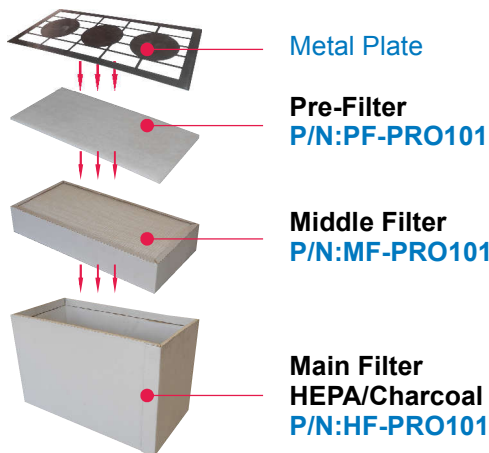

- **Metal Plate:** Metal Plate on top to increase the life of Filters
- **Stage I Pre-Filter (F7):** The Pre-Filter filters the bigger size particles for prolonging the life of both Middle and Main Filters.
- **Stage II Middle Filter:** It filters coarse size fume particles to prolong life of expensive HEPA/Charcoal Filter
- **Stage III Main HEPA/Charcoal Filter (H13):** This Filter is a combination of HEPA (filters fine size fume particles) and Activated Charcoal (absorbs harmful gas substances) Filters to provide clean air finally.

1. Normally Pre-Filter only needs periodic replacement when there is less suction of fumes.
2. These Filters should never be washed nor should be cleaned with compressed air at all.

shown trademarks are property of their respective owners.

Warranty is 12 months from the date of invoice. It excludes all consumable parts as Filters, Extraction Arms and Hoods

While the information contained herein in, has been carefully compiled to the best of our knowledge, nothing is intended as representation and warranty on our part; and no statement shall be construed as recommendation to infringe any of existing patents. We accept no liability of whatsoever for any faults and errors in the information contained herein. Contents of this catalogue and specifications of the products, are subject to change without notice due to continuous improvements.

Couple of 100's (in repeat orders) working reliably all over India for the last many years

**3-Stage Filters for 99.97% fumes cleaning**  
**Pre-Cut Metal Plate increases life of 3 Filters**  
**Silent operation with low noise < 60 dBA\***  
**Reliable and powerful brushless Turbine**



Rigid Gooseneck Arms can be positioned anywhere on table and will stay in same place



ESD Safe Main Extraction Unit



Speed Control Regulator

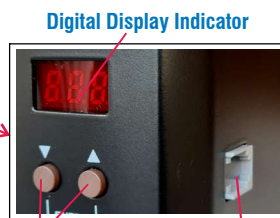

Digital Display Indicator  
Airflow Setting Connector for Speed Control Regulator



Burn-proof Silicon Round Hoods

No Plumbing required just position on or under the Table as needed

Ready-to-use Complete Package

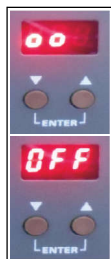

**System Choke Alarm:**  
When display shows circular movement clockwise plus OFF and system beeps, it means any of Filters needs replacement.

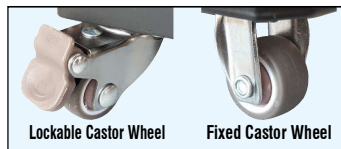

Lockable Castor Wheel Fixed Castor Wheel  
Caster wheels for easy & effortless mobility

[Click here to view Video](#)

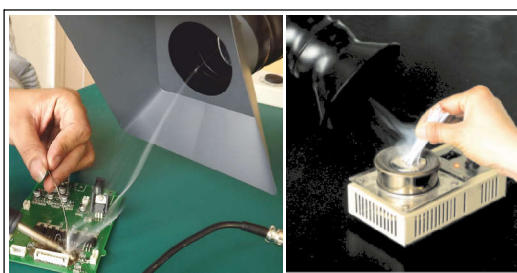

Solder fumes extraction during hand soldering on PCB and Solder Pot tinning

- ⇒ Complete Unit is ESD Safe
- ⇒ Pre-cut Metal Plate to increase the life of Filters
- ⇒ Change Pre-Filters periodically to get the maximum life of Middle Filters and Main HEPA Filters.
- ⇒ Please keep at least 20 Pre-Filters in stock to increase the life of Middle Filters and HEPA Filters
- ⇒ No special installation is required. This is just plug-in and use type instrument
- ⇒ See the video for more details

**Scope of Supply**

- 1xESD Safe Black Colour Main unit
- 2xESD Safe Extraction Arms (75mm diameter, 1.2 meter long)
- 2xBurn proof Round Silicon Rubber Hoods
- 1xSpeed Control Regulator
- 2xSpare Pre-Filters

**Specifications**

- Input Power Supply : 230V/50Hz, 250W
- No of Workplaces : 2
- Stationary Pressure : 3000 Pa
- Maximum Airflow Rate : 240m<sup>3</sup>/h
- Filtering Efficiency (0.3um) : 99.97%
- Noise Level : <60dB\*
- Dimension (LxWxH) (approx) : 470x230x500mm

\* at distance of 1 meter & also at typical speed of turbine

Warranty is 12 months from the date of invoice. It excludes any sort of mechanical damage and all consumable parts as Filters, Extraction Arms and Hoods.

on-site services can be provided at extra charges if pre-paid by customer in advance

While the information contained herein in, has been carefully compiled to the best of our knowledge, nothing is intended as representation and warranty on our part; and no statement shall be construed as recommendation to infringe any of existing patents. We accept no liability of whatsoever for any faults and errors in the information contained herein. Contents of this catalogue and specifications of the products, are subject to change without notice due to continuous improvements.

Couple of 100's (in repeat orders) working reliably all over India for the last many years

### Features

- Hassle-free easy-to-start operation with all inclusive kit supplied
- Easy-to-manoeuvre positioning of Fumes Extraction Arms
- Reliable & virtually maintenance-free Brushless DC Turbine
- Has low noise (< 60 dBA) in operation continuous running
- Specially designed Filters to remove hazardous gaseous/adhesive substances from fumes
- Low running cost as normally low cost Pre-Filter mainly needs replacement periodically as and when there is choking in fumes extraction
- Readily availability of all spare parts from stock



Length of the Extraction Arm is easily adjustable, as this is made from press-fit type small sections which are easily adjustable in length by selection of these sections as per required length.

FES2-75ESD-LC is a reliable and really effective volume extraction type 2-operators ready-to-use Solder Fume Extraction System. It is designed for continuous and reliable working on production line. Its powerful and maintenance-free brushless turbine combined with electronic speed control, provides clean working environment at low maintenance cost. The electronic Speed Controller regulates air-flow volume continuously.

These ready-to-use Solder Fumes Extraction Systems are fitted with **3-stage Filters**: Pre-Filter, Middle Filter and HEPA/Charcoal Filter. Combination of these Filters cleans polluted air by separating 99.97% contaminated solder fumes. These Systems are designed to use both in industrial and laboratory environment. Only mains input Power Supply is required to operate these systems.

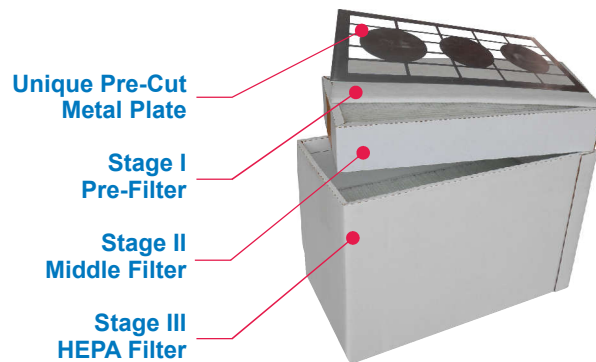

### Details of 3-Stage Filters and other Spares used in this Fume Extraction System

2-operators ready-to-use Solder Fumes Extraction System Model FES2-75ESD-LC is fitted with **3-stage Filters**: Pre-Filter, Middle Filter and HEPA/Charcoal Filter. Combination of these Filters cleans polluted air by separating 99.9% contaminated solder fumes. This System is designed for use both in industrial & laboratory environment. All it needs is mains input Power Supply only.

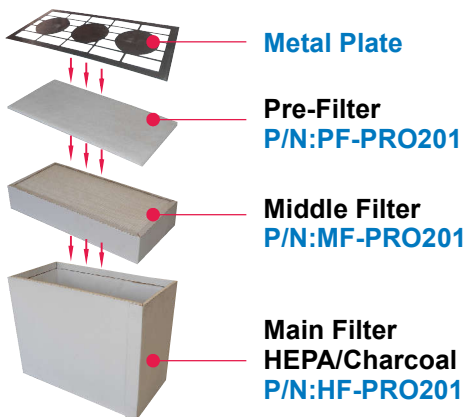

- **Metal Plate:** Metal Plate on top to increase the life of Filters It absorbs the heat of the fumes and prolongs the life of Filters
- **Stage I Pre-Filter (F7):** The Pre-Filter filters the bigger size particles for prolonging the life of both Middle and Main Filters.
- **Stage II Middle Filter:** It filters coarse size fume particles to prolong life of expensive HEPA/Charcoal Filter
- **Stage III Main HEPA/Charcoal Filter (H13):** This Filter is a combination of HEPA (filters fine size fume particles) and Activated Charcoal (absorbs harmful gas substances) Filters to provide clean air finally.

**Note: These 3 Filters should never be washed nor should be cleaned with compressed air at all.**

Warranty is 12 months from the date of invoice. It excludes any sort of mechanical damage and all consumable parts as Filters, Extraction Arms and Hoods.

**on-site services can be provided at extra charges if pre-paid by customer in advance**

While the information contained herein in, has been carefully compiled to the best of our knowledge, nothing is intended as representation and warranty on our part; and no statement shall be construed as recommendation to infringe any of existing patents. We accept no liability of whatsoever for any faults and errors in the information contained herein. Contents of this catalogue and specifications of the products, are subject to change without notice due to continuous improvements.

powerful maintenance-free Brushless Turbine • supplied with all accessories

3-Stage Filters for 99.97% fumes cleaning  
Pre-Cut Metal Plate increases life of 3 Filters  
Silent operation with low noise < 60 dBA\*  
Reliable and powerful brushless Turbine

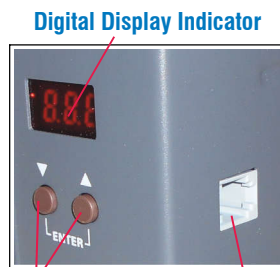

Setting Switches Connector for Speed Control Regulator

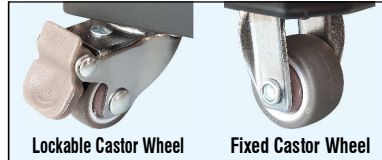

Caster wheels for easy & effortless mobility

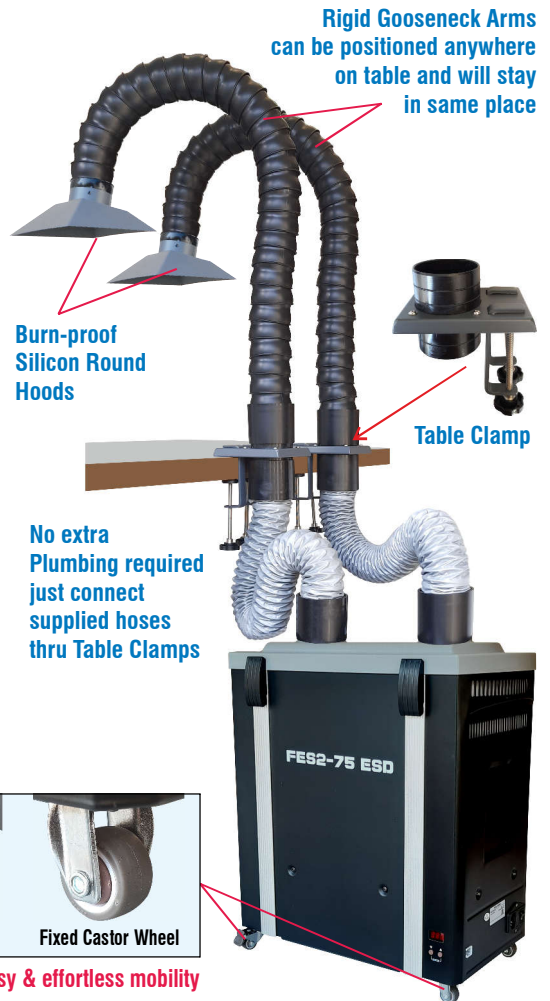

**System Choke Alarm:**  
When display shows circular movement clockwise plus OFF and system beeps, it means any of Filters needs replacement.

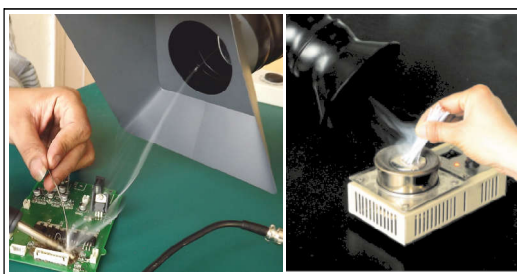

Solder fumes extraction during hand soldering on PCB and Solder Pot tinning

### Scope of Supply

- 1xESD Safe Black Colour Main unit
- 2xESD Safe Extraction Arms (75mm dia, 1.0 meter long)
- 2xBench Clamps
- 2xSoft Connection Hose
- 2xSquare Metallic Hoods (180x180mm)
- 1xSpeed Control Regulator
- 5xSpare Pre-Filters

### Specifications

- Input Power Supply : 230V/50Hz, 250W
- No of Workplaces : 2
- Stationary Pressure : 3000 Pa
- Maximum Airflow Rate : 240m<sup>3</sup>/h
- Filtering Efficiency (0.3um) : 99.97%
- Noise Level : <60dB\*
- Dimension (LxWxH) (approx) : 470x230x500mm

\* at distance of 1 meter & also at typical speed of turbine

Warranty is 12 months from the date of invoice. It excludes any sort of mechanical damage and all consumable parts as Filters, Extraction Arms and Hoods.

on-site services can be provided at extra charges if pre-paid by customer in advance

While the information contained herein in, has been carefully compiled to the best of our knowledge, nothing is intended as representation and warranty on our part; and no statement shall be construed as recommendation to infringe any of existing patents. We accept no liability of whatsoever for any faults and errors in the information contained herein. Contents of this catalogue and specifications of the products, are subject to change without notice due to continuous improvements.



powerful maintenance-free Brushless Turbine • supplied with all accessories

### Features

- Hassle-free easy-to-start operation with all inclusive kit supplied
- Easy-to-manoeuvre positioning of Fumes Extraction Arms
- Reliable & virtually maintenance-free Brushless DC Turbine
- Has low noise (< 60 dBA) in operation continuous running
- Specially designed Filters to remove hazardous gaseous/adhesive substances from fumes
- Low running cost as normally low cost Pre-Filter mainly needs replacement periodically as and when there is choking in fumes extraction
- Readily availability of all spare parts from stock



Length of the Extraction Arm is easily adjustable, as this is made from press-fit type small sections which are easily adjustable in length by selection of these sections as per required length.

FES2-75ESD-TC is a reliable and really effective volume extraction type 2-operators ready-to-use Solder Fume Extraction System. It is designed for continuous and reliable working on production line. Its powerful and maintenance-free brushless turbine combined with electronic speed control, provides clean working environment at low maintenance cost. The electronic Speed Controller regulates air-flow volume continuously.

These ready-to-use Solder Fumes Extraction Systems are fitted with **3-stage Filters**: Pre-Filter, Middle Filter and HEPA/Charcoal Filter. Combination of these Filters cleans polluted air by separating 99.97% contaminated solder fumes. These Systems are designed to use both in industrial and laboratory environment. Only mains input Power Supply is required to operate these systems.

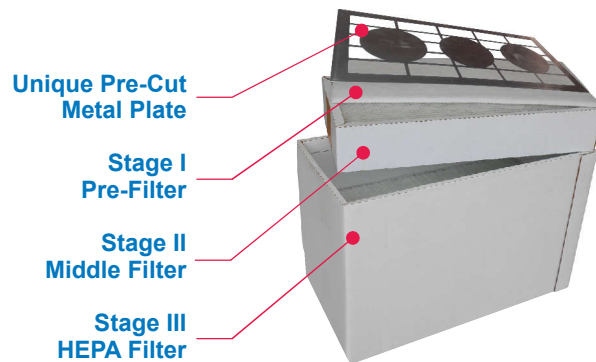

### Details of 3-Stage Filters and other Spares used in this Fume Extraction System

2-operators ready-to-use Solder Fumes Extraction System Model FES2-75ESD-TC is fitted with **3-stage Filters**: Pre-Filter, Middle Filter and HEPA/Charcoal Filter. Combination of these Filters cleans polluted air by separating 99.9% contaminated solder fumes. This System is designed for use both in industrial & laboratory environment. All it needs is mains input Power Supply only.

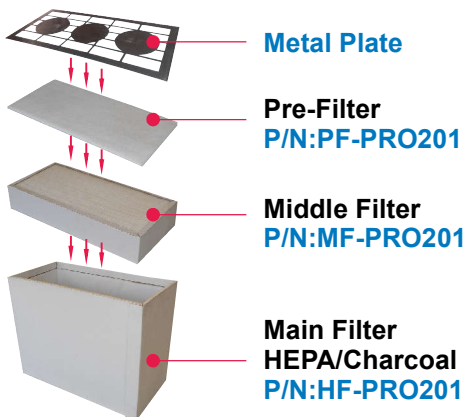

- **Metal Plate:** Metal Plate on top to increase the life of Filters It absorbs the heat of the fumes and prolongs the life of Filters
- **Stage I Pre-Filter (F7):** The Pre-Filter filters the bigger size particles for prolonging the life of both Middle and Main Filters.
- **Stage II Middle Filter:** It filters coarse size fume particles to prolong life of expensive HEPA/Charcoal Filter
- **Stage III Main HEPA/Charcoal Filter (H13):** This Filter is a combination of HEPA (filters fine size fume particles) and Activated Charcoal (absorbs harmful gas substances) Filters to provide clean air finally.

**Note: These 3 Filters should never be washed nor should be cleaned with compressed air at all.**

Warranty is 12 months from the date of invoice. It excludes any sort of mechanical damage and all consumable parts as Filters, Extraction Arms and Hoods.

on-site services can be provided at extra charges if pre-paid by customer in advance

While the information contained herein in, has been carefully compiled to the best of our knowledge, nothing is intended as representation and warranty on our part; and no statement shall be construed as recommendation to infringe any of existing patents. We accept no liability of whatsoever for any faults and errors in the information contained herein. Contents of this catalogue and specifications of the products, are subject to change without notice due to continuous improvements.

# Portable yet *effective* Solder Fume Extractor Model SFE-1L

Ideal replacement against fan type fume absorbers which just blow the fume to other side

**3 Filters for effective cleaning**  
**Noise-free Silent operation**  
**Reliable & powerful turbine**  
**Ready-to-use, without plumbing**



## Features:

- Fitted with a multi-layer filtration system for rapid purification, making it ideal for soldering fumes purification
- Compact in size with optimized airflow to filter fumes, dust and odor from soldering works and other conditons
- Adjustable fan speeds ranging from 1 to 100 with LED display for indicating current fan speed setting
- Easy-to-manoeuvre positioning of Flexible Corrugated Hose

Ready-to-use Solder Fume Extractor Model SFE-1L is fitted with **3-stage Filters**: Pre-Filter, HEPA Dust Filter and Activated Carbon Filter. Combination of these Filters cleans air by separating contaminated solder fumes. This Fume Extractor is designed for use in industrial and laboratory environment. All it needs is the Mains Input Power Supply only.

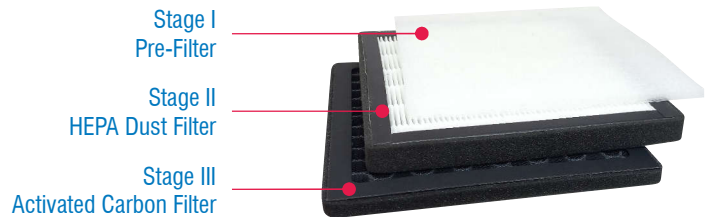

## Scope of Supply

- 1xSFE-1L Main Extraction Unit
- 1xFlexible Extraction Arm (60mm dia, 680mm long)
- 1xBurn-proof Silicon Absorbing Hood
- 1xPower Supply Adaptor (12V/2A)
- 3xSpare Pre-Filters

## Specifications

- Input Power Supply : 12V/2A
- No of Workplaces : 1
- Power Consumption : 15 Watt
- Adjustable Fan Speed ranging from 10 to 100
- LED display for fan speed indication

## Which one should you choose between: Fume Extractor and Fan type Fume Absorber

The answer is simple - Just Go with the Fume Extractor. A fan type absorber will just blow around the smoke produced and not filter it completely. A Fume Extractor not only sucks the fumes but it also filters the fumes. Despite its cost, a Solder Fume Extractor is way superior and efficient option.

**Filtration Process of SFE-1L Fume Extractor**

**Pre-Filter**  
Filter out larger particles of solder fumes

**Middle HEPA Filter**  
Filter out coarse particles of solder fumes and also filter out bacteria, fungi etc.

**Activated Carbon Filter**  
Filter out all toxic and harmful gases to make the air pure and free from pollutant

**Filtration Process of Fan type Fume Absorber**

**Carbon Activated Filter**  
Filter out solder fumes partially not completely Just blow the smoke to other side

**Partial pure air after filtration**

Warranty is 12 months from the date of invoice. It excludes all consumable parts as Filters, Extraction Arms and Hoods

shown trademarks are property of their respective owners.

While the information contained herein in, has been carefully compiled to the best of our knowledge, nothing is intended as representation and warranty on our part; and no statement shall be construed as recommendation to infringe any of existing patents. We accept no liability of whatsoever for any faults and errors in the information contained herein. Contents of this catalogue and specifications of the products, are subject to change without notice due to continuous improvements.