

- **LR 21 Soldering Pencil** is used in Model WECP20, EC2002, WS50, WS51, WSD50, WSD51, WS81 Soldering Stations

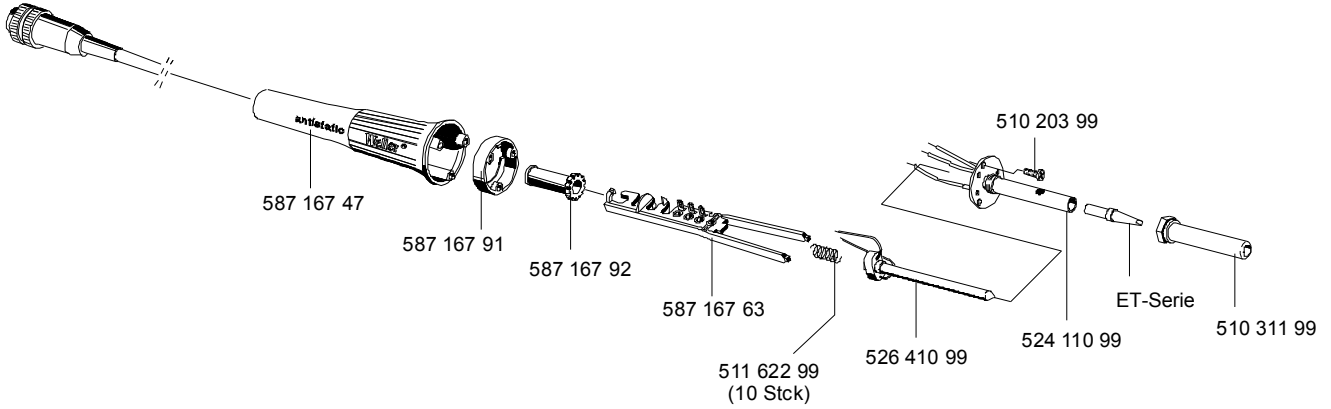

- **WSP80 Soldering Pencil** is used in Model WSD80, WSD81, WS80, WS81 Soldering Stations

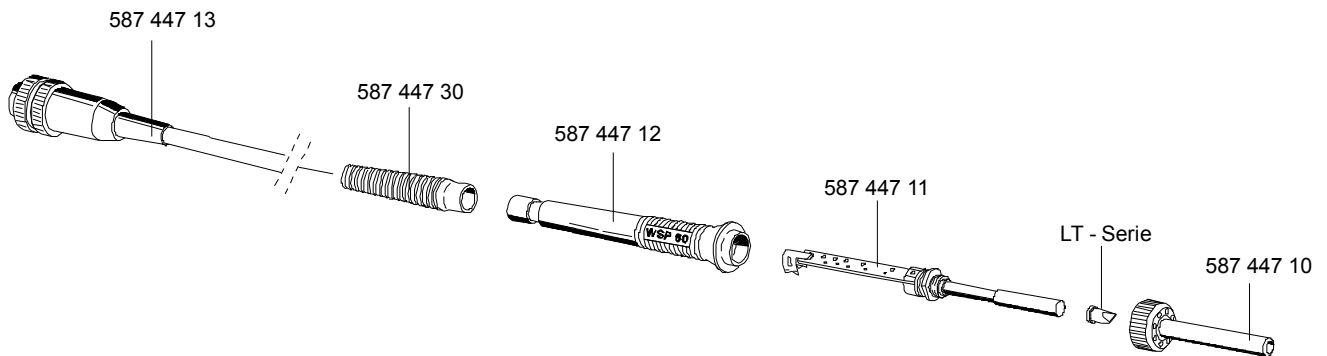

- **WP80 Soldering Pencil** is used in Model WSD80, WSD81, WS80, WS81 Soldering Stations

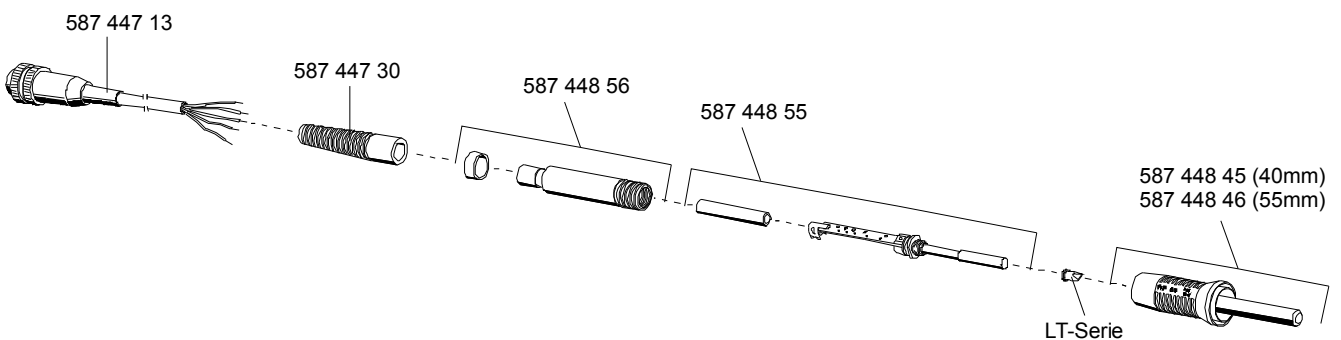









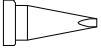
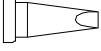
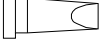
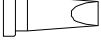
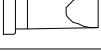



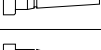
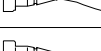
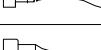
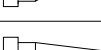

shown trademarks are property of their respective owners.

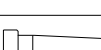
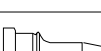
While the information contained herein in, has been carefully compiled to the best of our knowledge, nothing is intended as representation and warranty on our part; and no statement shall be construed as recommendation to infringe any of existing patents. We accept no liability of whatsoever for any faults and errors in the information contained herein. Contents of this catalogue and specifications of the products, are subject to change without notice due to continuous improvements.

Warranty excludes all consumable parts as Heating Elements, Temperature Sensors, Soldering/Desoldering/Hot Air Tips, Cleaning Sponges, Cleaning Brass Wool

for WSP80 and WP80 Soldering Pencils

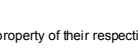
	Description
	LT H Chisel Soldering Tip 0.8 mm width
	LT A Chisel Soldering Tip 1.6 mm width
	LT B Chisel Soldering Tip 2.4 mm width
	LT C Chisel Soldering Tip 3.2 mm width
	LT D Chisel Soldering Tip 4.6 mm width
	LT K Long Chisel Soldering Tip 1.2 mm width
	LT L Long Chisel Soldering Tip 2.0 mm width
	LT M Long Chisel Soldering Tip 3.2 mm width
	LT 1 Round Soldering Tip 0.25 mm dia
	LT AS Round Soldering Tip 1.6 mm dia
	LT CS Round Soldering Tip 3.2 mm dia
	LT 4X Round Bent Soldering Tip 1.2 mm dia
	LT AX Chisel Bent Soldering Tip 1.6 mm
	LT 4 Sloped Round Soldering Tip 1.2 mm dia
	LT F Sloped Round Soldering Tip 1.2 mm dia
	LT BB Sloped 60° Round Soldering Tip 2.4 mm dia
	LT CC Sloped 60° Round Soldering Tip 3.2 mm dia
	LT 1S Round Slim Soldering Tip 0.2 mm dia
	LT 1SC Round Slim Soldering Tip 0.4 mm dia
	LT 1L Conical Long Soldering Tip 0.2 mm dia
	LT S Conical Long Soldering Tip 0.4 mm dia
	LT O Conical Long Soldering Tip 0.8 mm dia
	LT GW Gull Wing SMD Soldering Tip

shown trademarks are property of their respective owners.







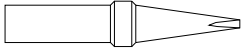
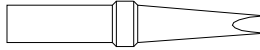
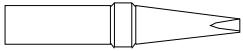
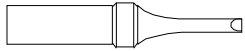
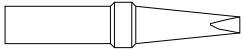
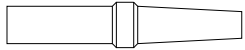
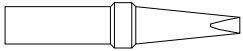
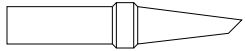
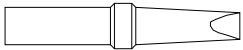
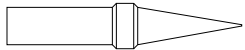
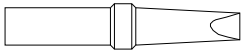
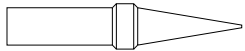
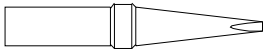
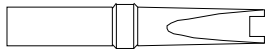
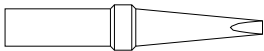
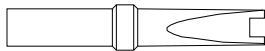



These Soldering Tips are consumable items and have no warranty.

While the information contained herein in, has been carefully compiled to the best of our knowledge, nothing is intended as representation and warranty on our part; and no statement shall be construed as recommendation to infringe any of existing patents. We accept no liability of whatsoever for any faults and errors in the information contained herein. Contents of this catalogue and specifications of the products, are subject to change without notice due to continuous improvements.

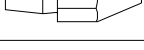
ET series Soldering Tips, normally ex-stock, for LR 21 Soldering Pencil

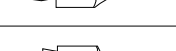
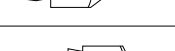
	ET H Chisel Soldering Tip 0.8 mm		ET M Long Chisel Soldering Tip 3.2 mm
	ET A Chisel Soldering Tip 1.6 mm		ET R Slim Chisel Soldering Tip 1.6 mm
	ET B Chisel Soldering Tip 2.4 mm		ET DS Round Soldering Tip 4.6 mm
	ET C Chisel Soldering Tip 3.2 mm		ET F Round 45° Sloped Soldering Tip 1.2 mm dia
	ET D Chisel Soldering Tip 4.6 mm		ET S Micropoint Soldering Tip 0.4 mm
	ET E Chisel Soldering Tip 5.6 mm		ET O Micropoint Soldering Tip 0.8 mm
	ET K Long Chisel Soldering Tip 1.2 mm		ET SMD Chip Soldering Tip 2.5mm x 1.5mm
	ET L Long Chisel Soldering Tip 2.0 mm		ET SMD Chip Soldering Tip 3.8mm x 1.5mm

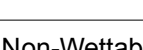
DX series Desoldering Nozzles, normally ex-stock, for DSX 80 Desoldering Pencil

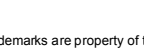
	DX 110 Desoldering Nozzle inside dia 0.7 mm		DX 111 Desoldering Nozzle inside dia 0.7 mm
	DX 112 Desoldering Nozzle inside dia 1.2 mm		DX 113 Desoldering Nozzle inside dia 0.7 mm
	DX 113HM High Mass Desoldering Nozzle, inside dia 1.2 mm		DX 114 Desoldering Nozzle inside dia 1.8 mm
	DX 115 Desoldering Nozzle inside dia 1.2 mm		DX 116 Desoldering Nozzle inside dia 1.2 mm
	DX 117 Desoldering Nozzle inside dia 1.5 mm		DX 118 Desoldering Nozzle inside dia 1.5 mm
	DX 119 Desoldering Nozzle with Needle Tiplet Non-Wettable Stainless Steel tube for removal of Solder bridges, inside dia 1.0 mm		
	DX 120 Desoldering Nozzle inside dia 1.1 mm		

shown trademarks are property of their respective owners.

These Soldering Tips are consumable items and have no warranty.

While the information contained herein in, has been carefully compiled to the best of our knowledge, nothing is intended as representation and warranty on our part; and no statement shall be construed as recommendation to infringe any of existing patents. We accept no liability of whatsoever for any faults and errors in the information contained herein. Contents of this catalogue and specifications of the products, are subject to change without notice due to continuous improvements.

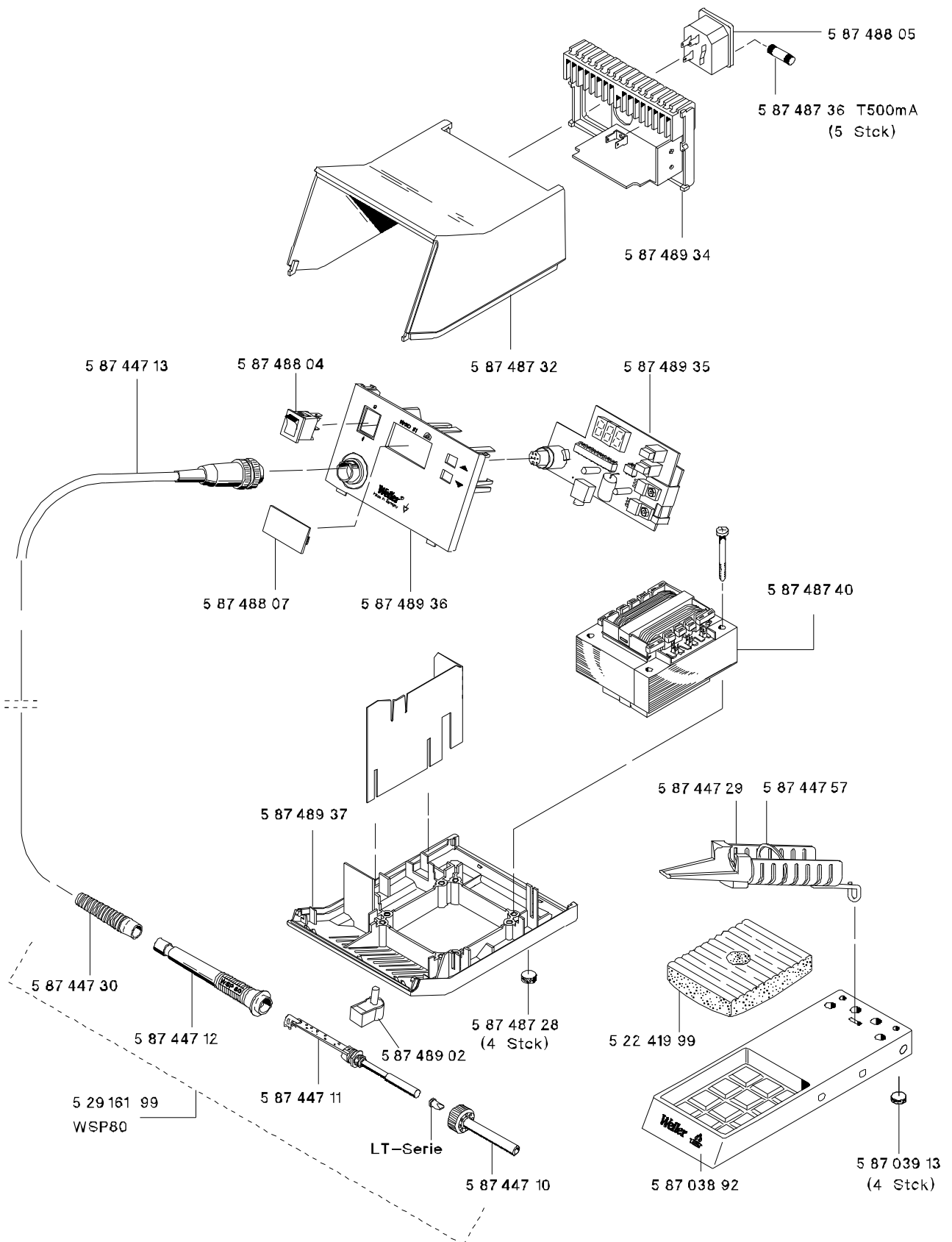

shown trademarks are property of their respective owners.

While the information contained herein in, has been carefully compiled to the best of our knowledge, nothing is intended as representation and warranty on our part; and no statement shall be construed as recommendation to infringe any of existing patents. We accept no liability of whatsoever for any faults and errors in the information contained herein. Contents of this catalogue and specifications of the products, are subject to change without notice due to continuous improvements.

Warranty excludes all consumable parts as Heating Elements, Temperature Sensors, Soldering/Desoldering/Hot Air Tips, Cleaning Sponges, Cleaning Brass Wool

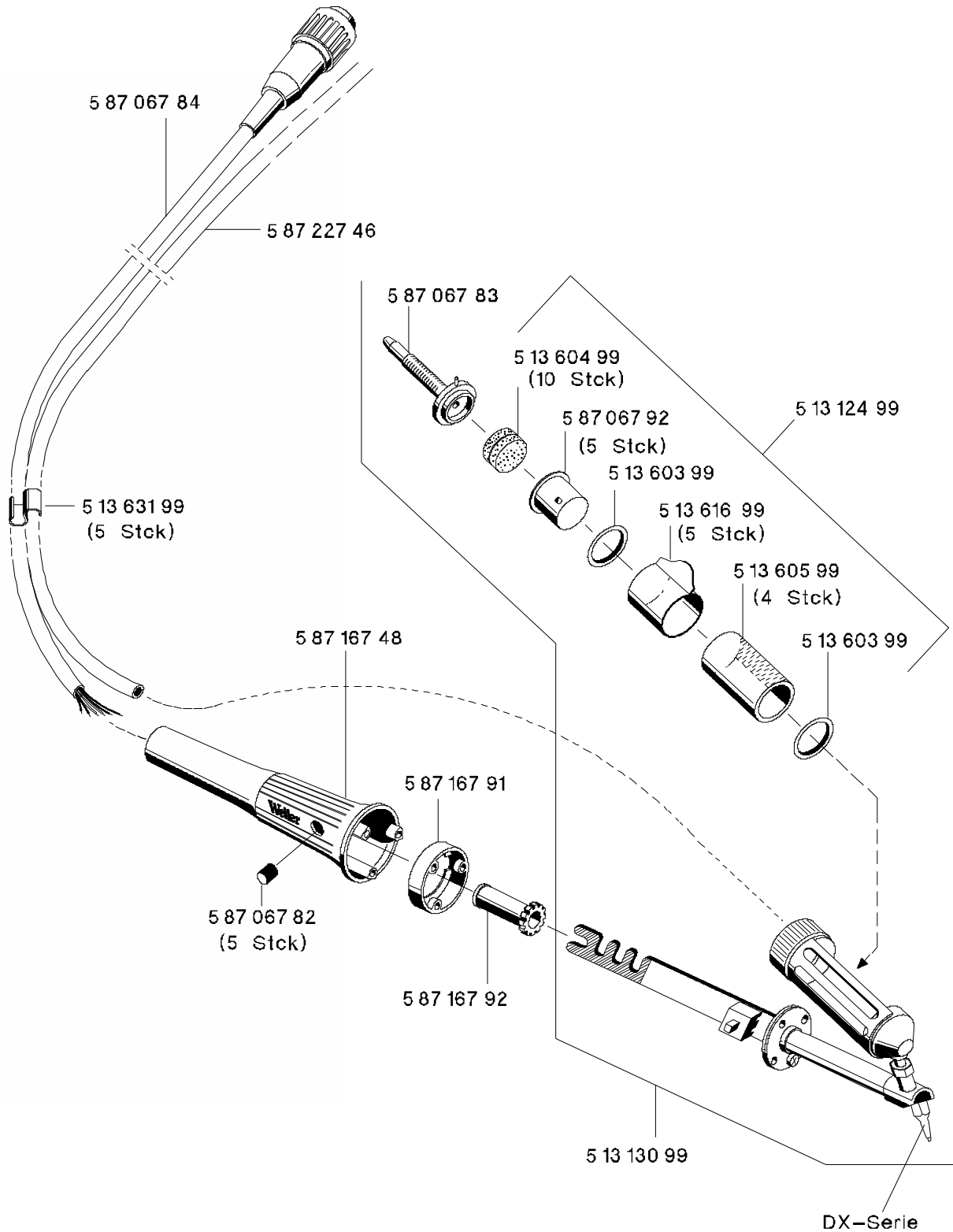

shown trademarks are property of their respective owners.

While the information contained herein in, has been carefully compiled to the best of our knowledge, nothing is intended as representation and warranty on our part; and no statement shall be construed as recommendation to infringe any of existing patents. We accept no liability of whatsoever for any faults and errors in the information contained herein. Contents of this catalogue and specifications of the products, are subject to change without notice due to continuous improvements.

Warranty excludes all consumable parts as Heating Elements, Temperature Sensors, Soldering/Desoldering/Hot Air Tips, Cleaning Sponges, Cleaning Brass Wool

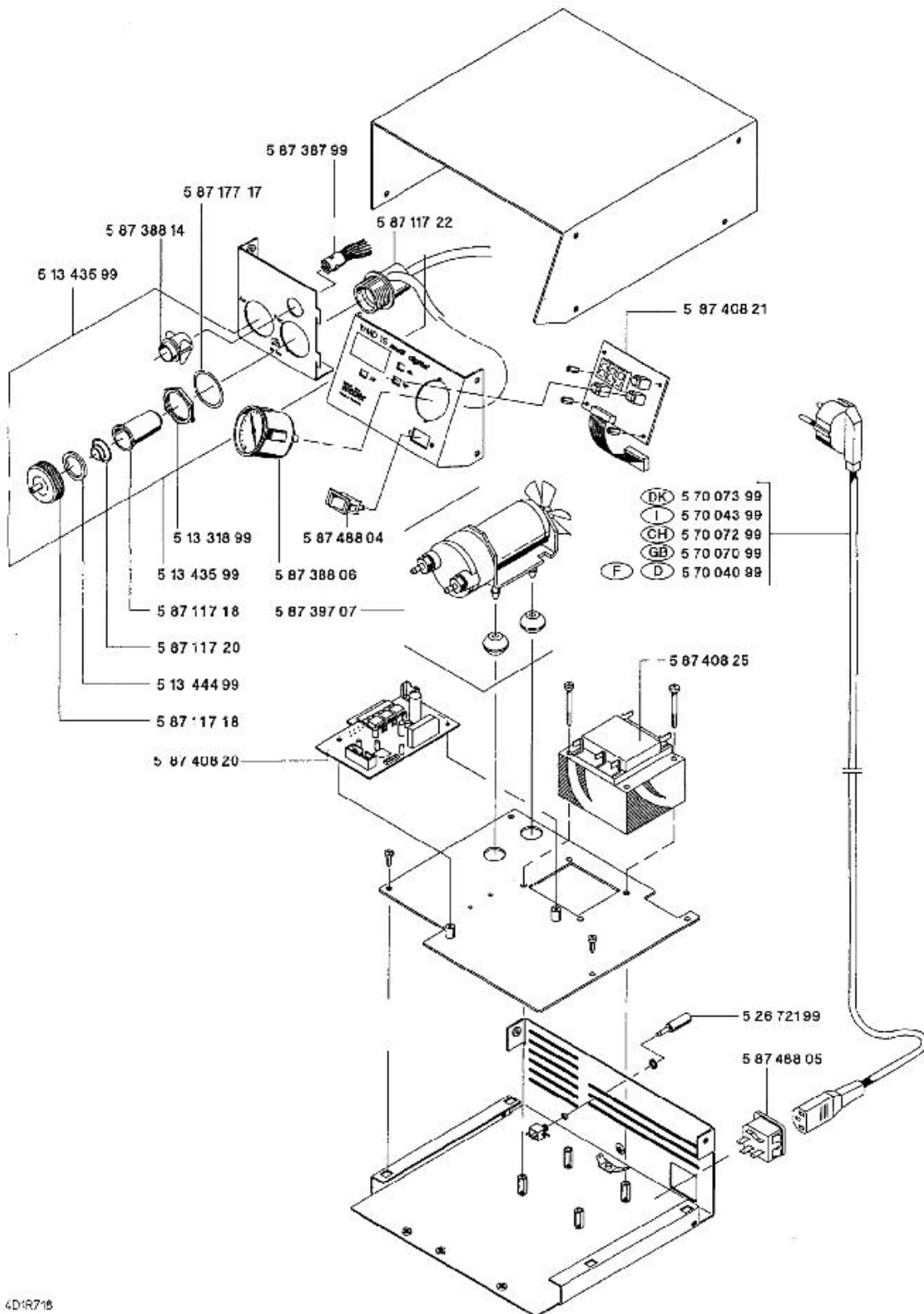

shown trademarks are property of their respective owners.

Warranty excludes all consumable parts as Heating Elements, Temperature Sensors, Soldering/Desoldering/Hot Air Tips, Cleaning Sponges, Cleaning Brass Wool

While the information contained herein in, has been carefully compiled to the best of our knowledge, nothing is intended as representation and warranty on our part; and no statement shall be construed as recommendation to infringe any of existing patents. We accept no liability of whatsoever for any faults and errors in the information contained herein. Contents of this catalogue and specifications of the products, are subject to change without notice due to continuous improvements.

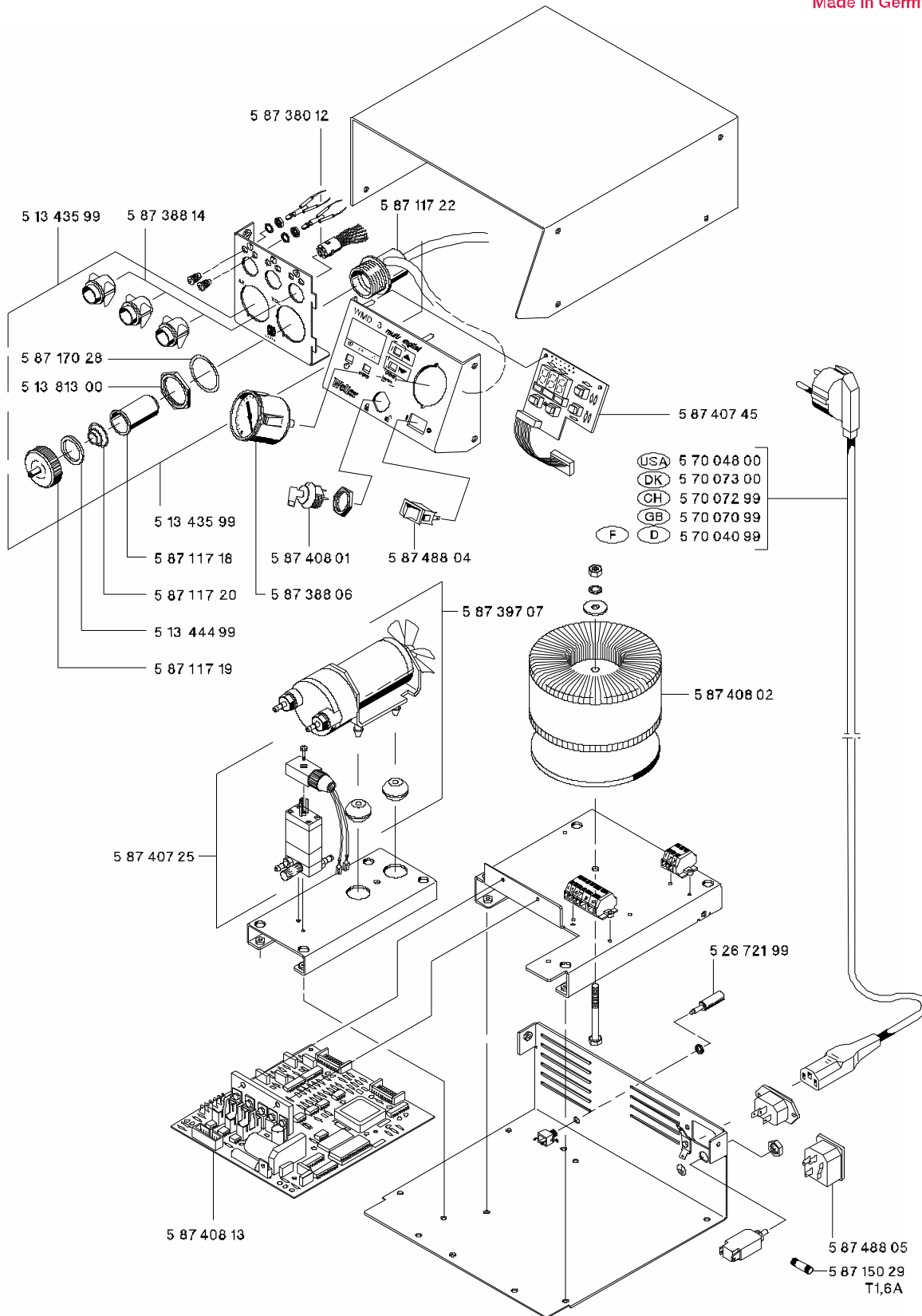

shown trademarks are property of their respective owners.

While the information contained herein in, has been carefully compiled to the best of our knowledge, nothing is intended as representation and warranty on our part; and no statement shall be construed as recommendation to infringe any of existing patents. We accept no liability of whatsoever for any faults and errors in the information contained herein. Contents of this catalogue and specifications of the products, are subject to change without notice due to continuous improvements.

Warranty excludes all consumable parts as Heating Elements, Temperature Sensors, Soldering/Desoldering/Hot Air Tips, Cleaning Sponges, Cleaning Brass Wool

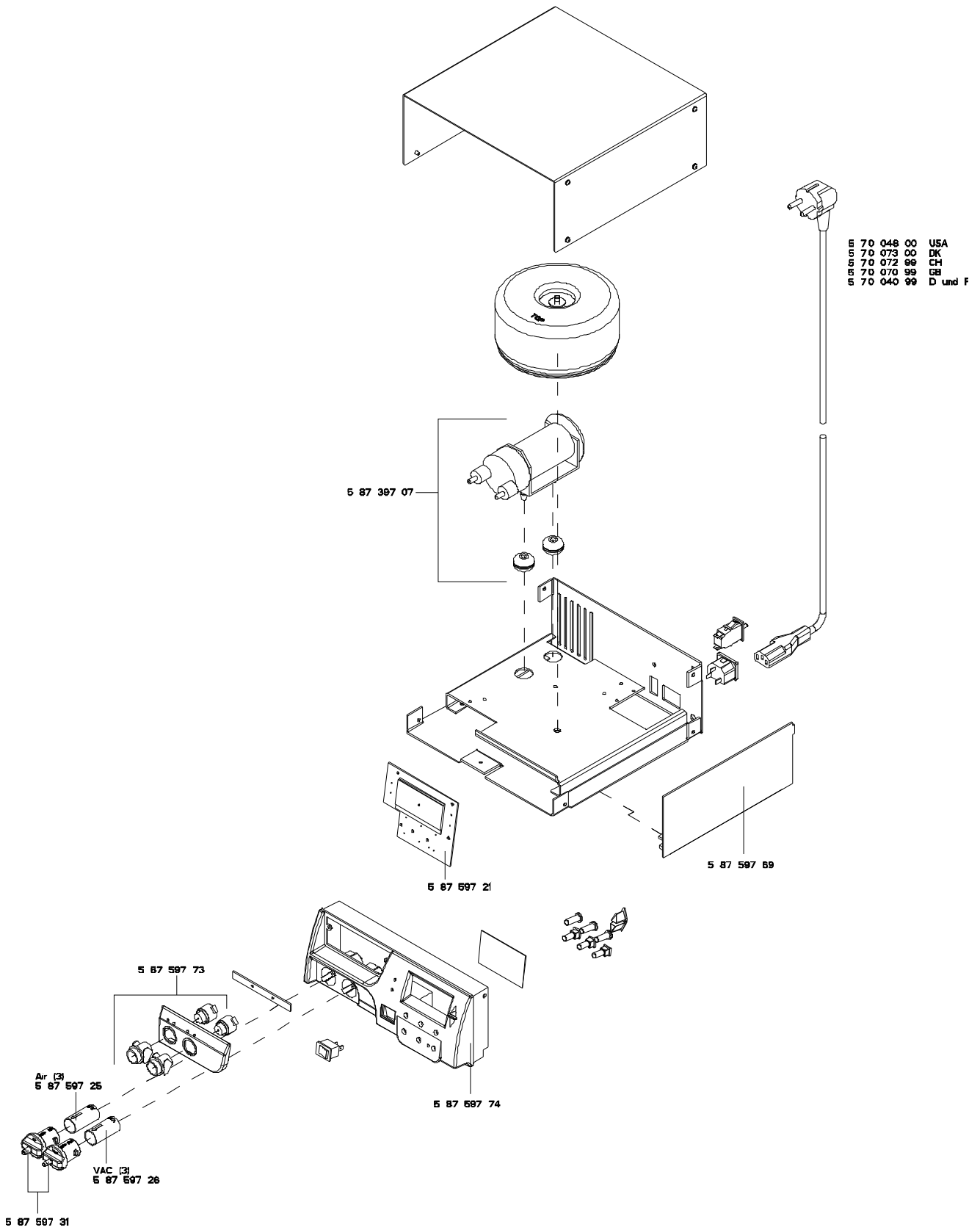

shown trademarks are property of their respective owners.

While the information contained herein in, has been carefully compiled to the best of our knowledge, nothing is intended as representation and warranty on our part; and no statement shall be construed as recommendation to infringe any of existing patents. We accept no liability of whatsoever for any faults and errors in the information contained herein. Contents of this catalogue and specifications of the products, are subject to change without notice due to continuous improvements.

Warranty excludes all consumable parts as Heating Elements, Temperature Sensors, Soldering/Desoldering/Hot Air Tips, Cleaning Sponges, Cleaning Brass Wool

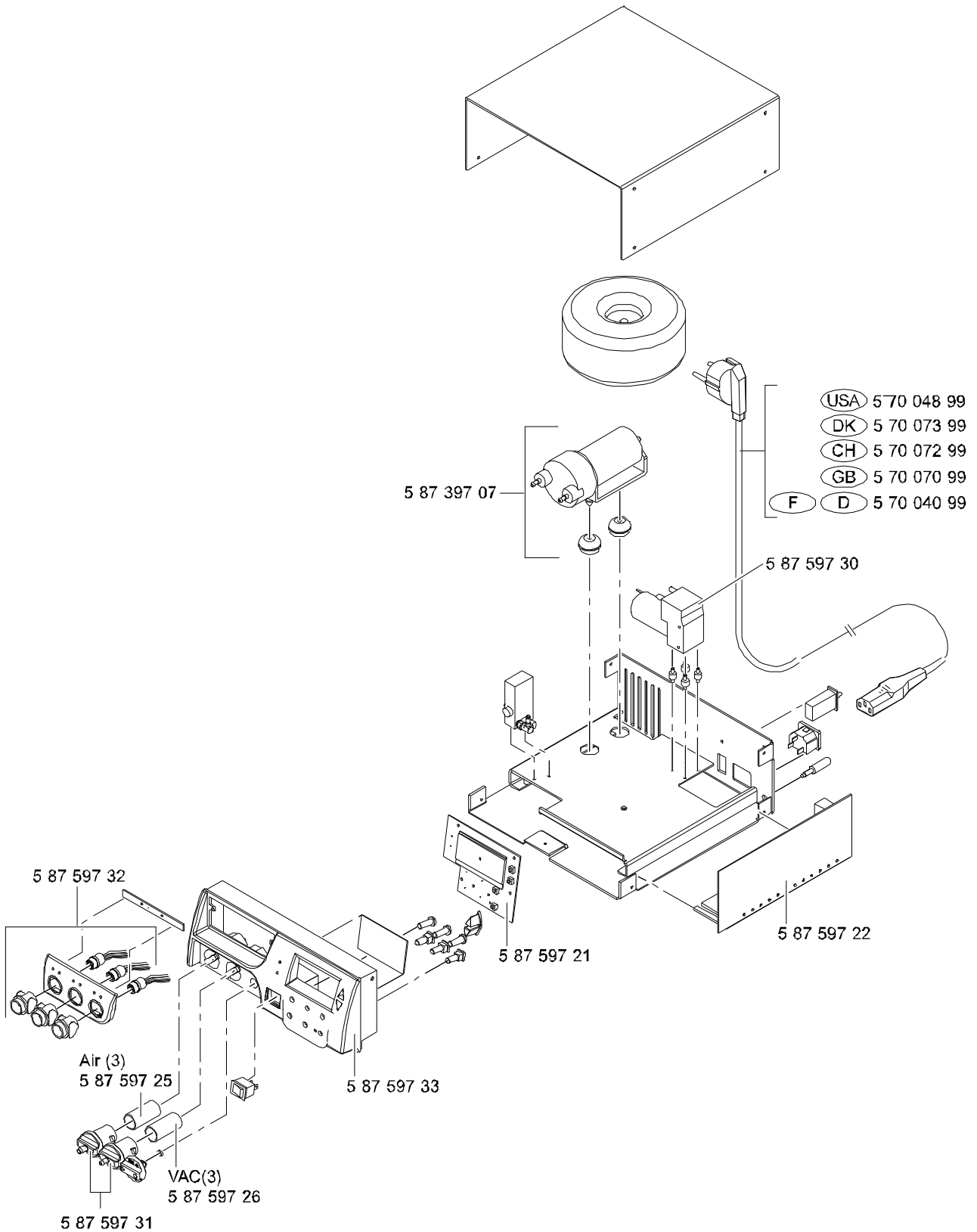

shown trademarks are property of their respective owners.

While the information contained herein in, has been carefully compiled to the best of our knowledge, nothing is intended as representation and warranty on our part; and no statement shall be construed as recommendation to infringe any of existing patents. We accept no liability of whatsoever for any faults and errors in the information contained herein. Contents of this catalogue and specifications of the products, are subject to change without notice due to continuous improvements.

Warranty excludes all consumable parts as Heating Elements, Temperature Sensors, Soldering/Desoldering/Hot Air Tips, Cleaning Sponges, Cleaning Brass Wool