

**IEWRWP-MS2T-3M-PK1 Integrated Packages Include:**



- All inclusive package, no hassles for customer
- Developed from best of breed tools & accessories

- Covers SMD/PTH soldering & desoldering
- Ideal for service centers, Labs

**IEWRWP-MS2T-3M-PK1 Integrated Package Covers:**

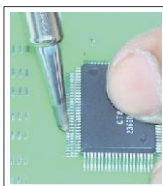

SMD ICs soldering



Thru-Hole desoldering

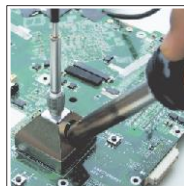

Large SMD Desoldering

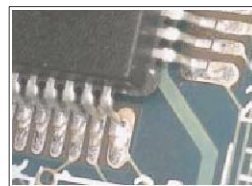

Visual Inspection



Fume Extraction

shown trademarks are property of their respective owners.

While the information contained herein in, has been carefully compiled to the best of our knowledge, nothing is intended as representation and warranty on our part; and no statement shall be construed as recommendation to infringe any of existing patents. We accept no liability of whatsoever for any faults and errors in the information contained herein. Contents of this catalogue and specifications of the products, are subject to change without notice due to continuous improvements.

Connects to Vacuum inlet on Control Unit for lifting QFPs & PLCCs gently without any damage to SMD pads

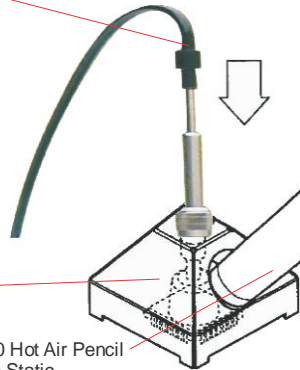

HAP 200 Hot Air Pencil provides Static Free hot air

**Weller®**  
Made in Germany

**WR3M-WRK System Package**

**includes**

- WR3M Main Control Unit
- HAP200 Hot Air Set
- DXV80 Desoldering Iron Set
- WP80 Soldering Iron Set
- WRK Nozzles Set

**Optional**

- WMRT Thermal Tweezers Set

**Innovative Hot Air Nozzles integrated with Vacuum Pick-up provision are placed directly on the PCB, and desolder QFPs, PLCCs & SOICs by hot air reflow and gentle vacuum lifting**

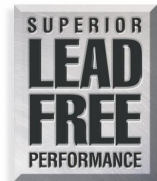
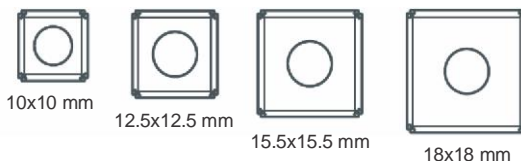
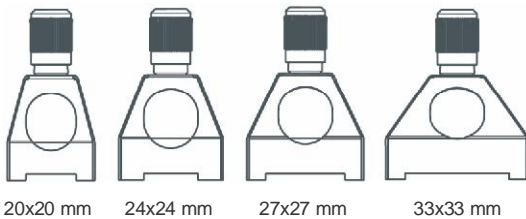

**new 200 watt powerful HAP 200** Hot Air Pencil is designed for use with new WRK Set of Hot Air Nozzles integrated with Vacuum Pick-up

in-built Antistatic Vacuum Pick-up Pen picks and places delicate SMD ICs

- 3 independent Heating Channels for:
- new 200 watt powerful Hot Air Pencil
  - Silverline 80 watt Soldering Pencil
  - in-line 80 watt Desoldering Pencil

- 2 in-built Powerful Vacuum Pumps**
- one for hot air and vacuum suction
  - second for vacuum pick-up functions

In-built USB Port for interface with customer's computer Software is part of supply



Air outlet for new 200 Watt Hot Air Pencil

Powerful vacuum inlet for in-line vertical Desoldering Pencil



"ESD" Safe

In-line powerful DXV 80 Desoldering Pencil desolders Thru-hole components on high multi-layer PC boards and heavily grounded PC boards effectively



Silverline WP 80 Soldering Pencil solders ultra fine pitch large SMD ICs reliably and without any bridges



Optionally available WTA 50 Thermal Tweezer desolders miniature SMD chip components

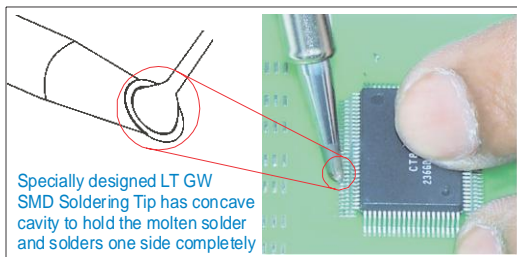

Specially designed LT GW SMD Soldering Tip has concave cavity to hold the molten solder and solders one side completely

WP 80 Soldering Pencil with SMD soldering tip



in-line DXV80 Desoldering Iron

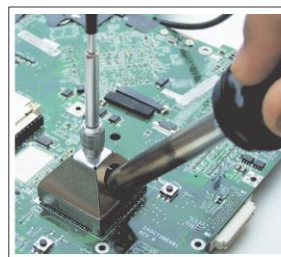

HAP 200 Hot Air Pencil with WRK Nozzle



In-built vacuum suction in Hot Air Nozzles lifts large SMD ICs gently.

shown trademarks are property of their respective owners.

While the information contained herein in, has been carefully compiled to the best of our knowledge, nothing is intended as representation and warranty on our part; and no statement shall be construed as recommendation to infringe any of existing patents. We accept no liability of whatsoever for any faults and errors in the information contained herein. Contents of this catalogue and specifications of the products, are subject to change without notice due to continuous improvements.



We offer high quality workstations meeting ESD safety standards and complete set fitted with necessary accessories to make a high utility workbench for users in electronics assembly. In addition to this standard configuration we can as well offer customized configurations in aluminium frame and other accessories can be fitted



*Delivered product may vary from the picture shown due to continuous developments and improvements*

### Features:

- Mild steel channels, powder coated
  - Includes a set of drawers
  - Includes lighting tube
- 2-tier construction with main work-surface and auxiliary work-surface
- Can be disassembled and re-assembled in case of movement
- Includes power raceway with pre-fitted power sockets

### Scope of Supply - Model IEW-MS2T0-1800x750









Description	Quantity
Size (WxDxH): 1800 X 750 X 1800 mm ; 5.9 X 2.46 x 5.9 feet	-
End Vertical frame : 25mmx50mm MS Slotted Tube, powder coated	-
Cross member tubes - CRCA Powder coated	-
Power Raceway with internal wiring	1
5/15Amps Power Sockets (fitted on power raceway)	5
15Amps Power Sockets (fitted on power raceway)	2
Network Raceway with cutouts only	1
Table Top (Edge Binded) – 1800mm (W) x 750mm (D)	1
Table Top (Edge Binded) – 1800mm (W) x 450mm (D)	1
Wooden Drawers – 450x450x685mm	2
Filing Drawers	1
4' Width Tube Light	1
MS Foot Rest	1
ESD Mat – 1800mm (W) x 750mm (D)	1
ESD Mat – 1800mm (W) x 450mm (D)	1
ESD Floor Mat - 3000mm x 1800mm	1
Wrist wraps	2
Grounding Chord	2
ESD Plastic Bins (90mmWx100mmDx60mmH)	6

*Please contact us for customized versions*







shown trademarks are property of their respective owners.

*While the information contained herein in, has been carefully compiled to the best of our knowledge, nothing is intended as representation and warranty on our part; and no statement shall be construed as recommendation to infringe any of existing patents. We accept no liability of whatsoever for any faults and errors in the information contained herein. Contents of this catalogue and specifications of the products, are subject to change without notice due to continuous improvements.*

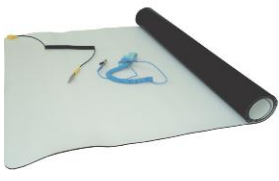
**Soldering & Rework Accessories and Tools in Package**

<p><b>Tip Activator</b></p>  <p>Model 51303199 De-oxidation of black tips</p>	<p><b>Solder Wire Stand</b></p>  <p>for easy dispensing of solder wire</p>	<p><b>Flux/Alcohol Dispensing Bottles</b></p>  <p>Model MS-035 &amp; ESD-DB-180</p>	<p><b>Soldering Aid Kit</b></p>  <p>Model GSR-107</p>
<p><b>PLCC Extractor</b></p> 	<p><b>Flux Pen</b></p> 	<p><b>Solder Wire Roll</b></p> 	<p><b>Desoldering Wick</b></p> <p>PCB Pad Preparation</p> 

**Electronics Workbench Accessories and Tools in Package**

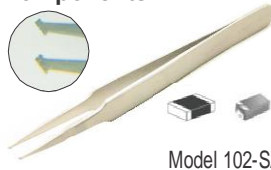
<p><b>ESD Mat Kit</b></p>  <p>Model 8BM-612A</p>	<p><b>Vacu-Vise Multi-angle Swivelling</b></p>  <p>PD-376 Vacu-Vise</p>	<p><b>Precision Cutter</b></p> <p>Heavy duty type</p>  <p>HT-222 Heavy Duty precision Cutter</p>	<p><b>ESD Safe Cleaning Brushes</b></p>  <p>ESD-A2 &amp; ESD-E2</p>
<p><b>Vacuum Pickup Pen for SMDs</b></p>  <p>Model ES37102</p>	<p><b>ESD Safe Soft Tip Tweezer</b></p>  <p>Model ESD-259AX</p>	<p><b>Superfine curved Tweezer</b></p>  <p>used with hot air gun for SMD removal Model 7-SA</p>	<p><b>SMD Tweezer for Chip Components</b></p>  <p>Model 102-SA</p>

**PCB Holder & Stand**

- Integrated Hot Air Pencil stand with circuit board holder
- Aluminium construction
- Maximum PCB size: 380x380mm



**Vacuum Pick-up Pen Electrically-operated**  
Model IVS-381

- ESD safe design
- Light-weight
- Adjustable vacuum upto 225mmHg
- Picks & places SMD chips, SOICs, QFPs

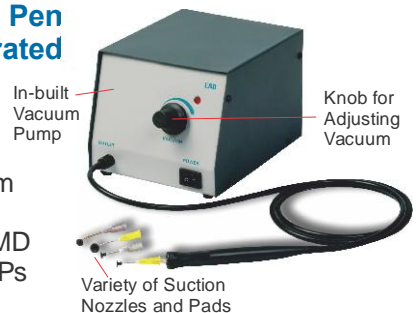

shown trademarks are property of their respective owners.

While the information contained herein in, has been carefully compiled to the best of our knowledge, nothing is intended as representation and warranty on our part; and no statement shall be construed as recommendation to infringe any of existing patents. We accept no liability of whatsoever for any faults and errors in the information contained herein. Contents of this catalogue and specifications of the products, are subject to change without notice due to continuous improvements.

### Scope of Supply of Package IEWRWP-MS2T-3M-PK1

Description	Qty Included
ESD Workstation complete	1
Weller WR3000M Multifunction Set, Includes: - Power & Control Unit - Hot Air Pencil with stand & 1 Round Nozzle - Soldering Pencil with 1 Soldering Tip and Stand - Desoldering Pencil with 1 Desoldering Nozzle and Stand - USB Interface Cable Monitoring Software	1
SMD Hot Air Nozzles Set, Includes - 10 x 10mm 12.5 x 12.5mm 15.5 x 15.5mm 20 x 20 mm 24 x 24 mm 27 x 27mm 33 x 33mm - Deposit Rack Tripod Pickup	1 Set
<b>Soldering Accessories</b>	
Solder Wire Stand	1
Solder Wire Roll, 250g	2
Desoldering Wick	3
Tip Activator	1
Flux Pen	2
Flux Bottle	2
Dispenser Bottle	2
Soldering Aid Kit	1
PLCC Extractor	1
<b>Workbench Accessories</b>	
VACU VICE	1
ESD Mat Kit	1
SMD Vacuum Pick-up Pen	1
Fine Tip Curved Tweezer	2
ESD Safe Soft Tip Tweezer	1
SMD Tweezer	1
Cutting Pliers	2
ESD Safe Cleaning Brush	2
ESD Safe Cleaning Brush	2
<b>Visual Inspection</b>	
Table Top LED magnifier, Black, Portable	1
<b>Placement &amp; Circuit Board</b>	
PCB Holder	1
Vacuum Pickup (electric)	
<b>Fume Extraction</b>	
Fume Absorber	1

shown trademarks are property of their respective owners.

While the information contained herein in, has been carefully compiled to the best of our knowledge, nothing is intended as representation and warranty on our part; and no statement shall be construed as recommendation to infringe any of existing patents. We accept no liability of whatsoever for any faults and errors in the information contained herein. Contents of this catalogue and specifications of the products, are subject to change without notice due to continuous improvements.